

550











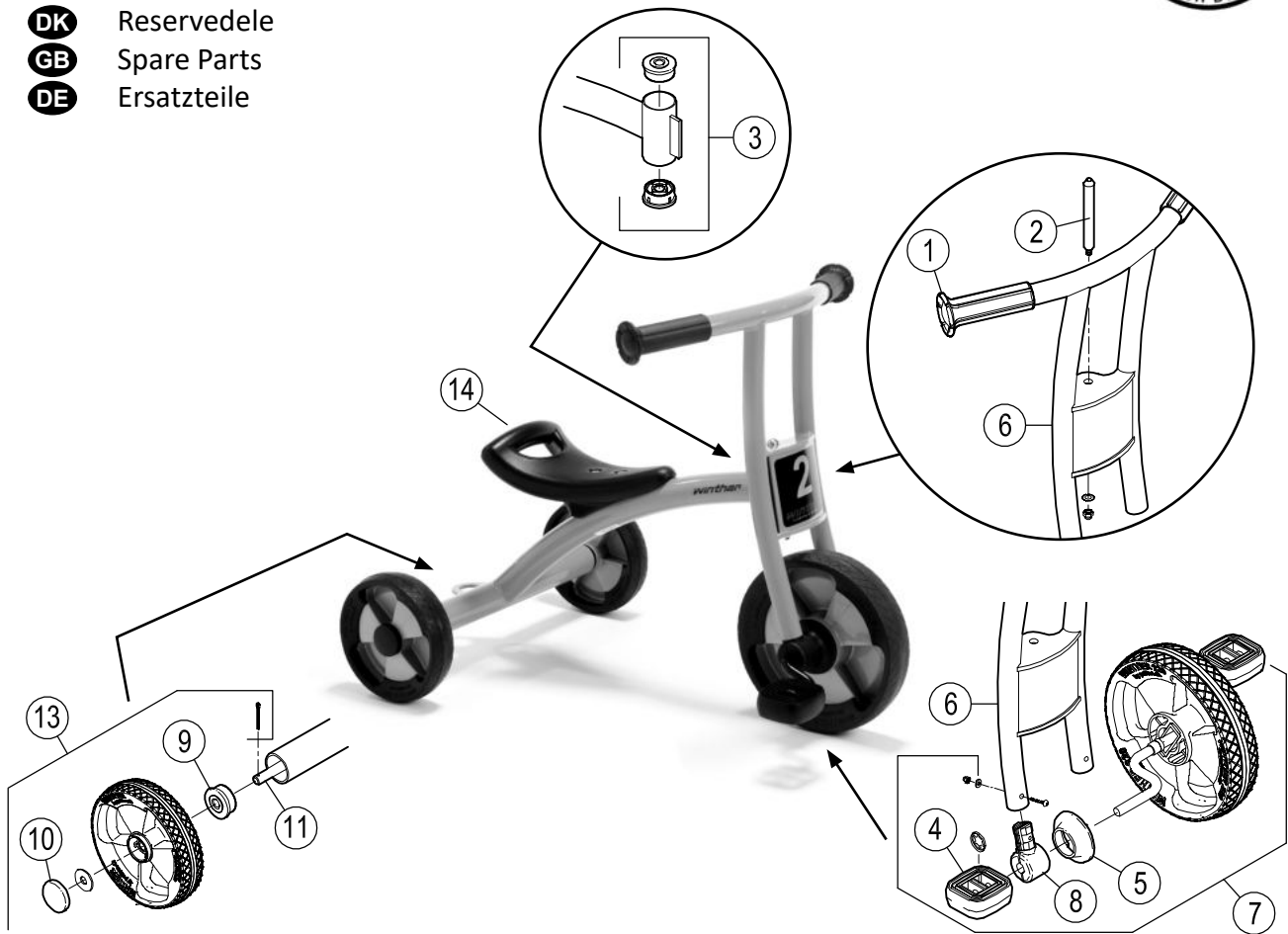











EN 71

ASTM F963

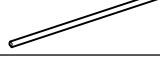

- DK** Reservedele
- GB** Spare Parts
- DE** Ersatzteile

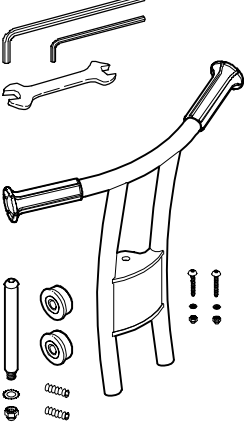
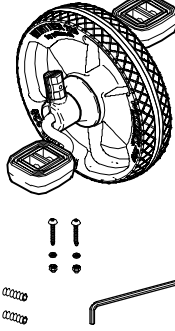
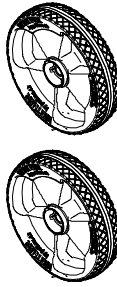
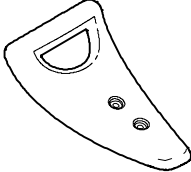

Pos.		Pos.	
1	 x2	8	 x2  x2  x2  x1
2	 x1  x2  x1  x1  x1	9	 x2
3	 x2	10	 x2
4	 x2  x2	11	 x1  x2  x2
5	 x2	12	
6		7	
13		14	



550



EN 71

ASTM F963



- DK** Reservedele
- GB** Spare Parts
- DE** Ersatzteile

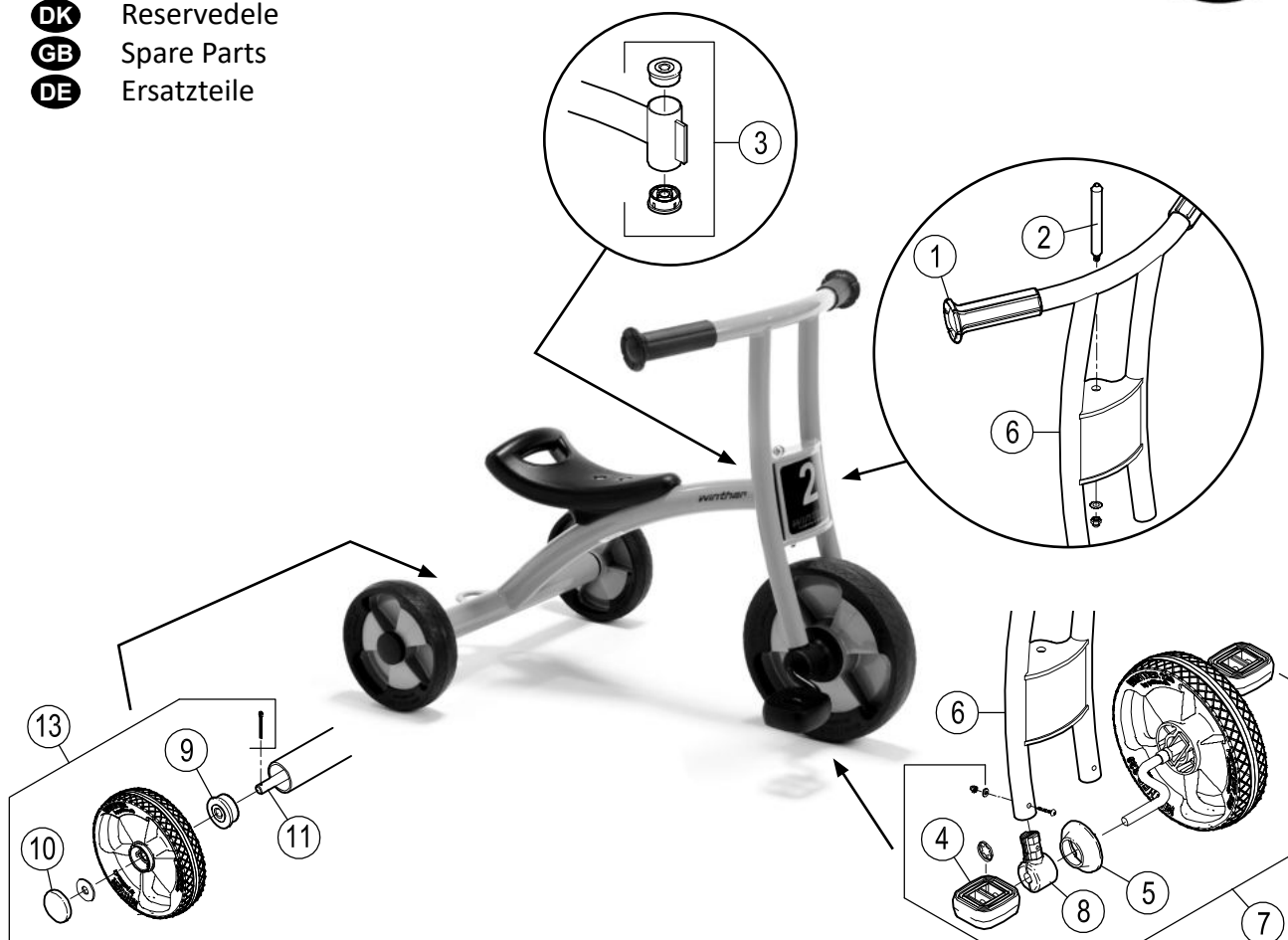

550.00					
Version					
Pos.	2.1				
1	50403				
2	50401				
3	50404				
4	50410				
5	50405				
6	50450				
7	50460				
8	50406				
9	50418				
10	50421				
11	50412				
12	-				
13	50470				
14	50480				
15	-				
16	-				
17	-				
18	-				

